

THE AIO SOLUTION® 3.0 BREAST- AND LUNGBOARD



Article Nos. :

38003	38102	38007	38117
38004	38200	38211/6	38118
38100	38201	38103	38223
38101	38202	38106	38236
38238	38130		

A. GENERAL PRODUCT INFORMATION

These products are medical devices used for positioning and immobilisation of breast and lung patients in supine position in radiation therapy. The products can be used during both the simulation and treatment stage, including MRI simulation.

To attain an optimal result, it is recommended to use this product in combination with Orfit immobilisation products.

B. PRODUCT DESCRIPTION

This AIO Solution® 3.0 Breast- and Lungboard is primarily used for the treatment of malignancies in the thorax and abdomen. The system includes a set of breast & lung position cushions and associated accessories. It is used in combination with the Raycast® High Precision Head Supports and Blocks & Wedges and the Efficast® Pre-cuts to form a reproducible patient positioning and immobilisation device in the field of radiotherapy. Information on these other parts and instructions on how to make the masks can be found in the respective 'instructions for use' and on www.orfit.com.

The AIO solution® 3.0 Breast- and Lungboard is a modular system of which the cushions and accessories can be indexed onto any AIO 3.0 base plate or directly onto the simulation and treatment couch. This allows the system being suitable for use in small bore CT and MRI scanners.

C. PRODUCT RANGE

Art. No.	Description
38003	AIO 3.0 - Secondary base plate - High density
38007	AIO 3.0 - Secondary base plate - Low density
38004	AIO 3.0 - Standalone grip pole block support frame
38100	AIO 3.0 - Arm rest high
38106	AIO 3.0 - Arm rest low
38101	AIO 3.0 - 0 degree cushion - Adult
38102	AIO 3.0 - Wedge 10°
38103	AIO 3.0 - Wedge 5°
38200	AIO 3.0 - Grip pole collar
38201	AIO 3.0 - Grip pole long
38202	AIO 3.0 - Indexing knob for cushions
38211/6	AIO 3.0 - Set of 6 pins for 0° cushions
38117	AIO 3.0 - 0 degree cushion for paediatric base plates – without leg separator
38118	AIO 3.0 - 0 degree cushion for paediatric base plates – with leg separator
38223	AIO 3.0 – Grip pole short
38236	AIO 3.0 – Grip pole collar connection pin
38238	AIO 3.0 – Grip pole extra long
38130	AIO 3.0 – Arm rest extension

D. PRECAUTIONS FOR USE

Breast- & lung board cushions 38100, 38106, 38101, 38102, 38103, 38211/6, 38117, 38118 & 38130

The cushions can be used in combination with the AIO 3.0 carbon fibre and fibreglass base plates or can be indexed directly onto the simulation and treatment couch.

When the Breast- and Lung board cushions are being used in combination with an AIO 3.0 base plate, always make sure that the base plate is fully supported by the simulation or treatment couch. The AIO 3.0 base plates cannot be used in overhang in combination with the AIO 3.0 breast and lung board cushions and accessories.

The 0 degree cushion for adult base plates (38101) fits in the cut-out provided in the AIO 3.0 adult base plates while the 0 degree cushions for paediatric base plates 38117 and 38118 respectively fit in the cut-out provided in the AIO 3.0 paediatric base plates 38011 and 38012. The 0 degree cushions can be fixed to the base plate using the set of 6 pins for 0° cushion (38211/6). These pins are pushed into the 6 small holes provided in the 0 degree cushion to keep the 0 degree cushion in place.



The 5° and 10° wedge cushions (38103 & 38102) can be indexed by inserting the widest part of the indexing knobs (38202) into the holes provided on the bottom side of the cushions.

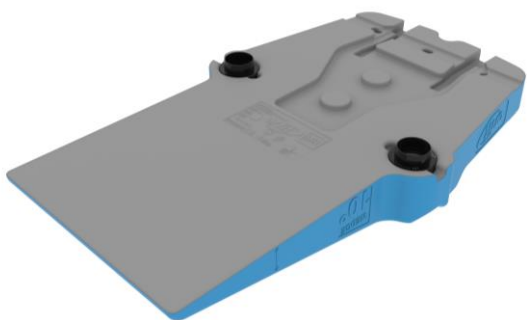

The protruding part of the indexing knobs will fit into the positioning holes provided in 0 degree cushion and the AIO 3.0 base plates.

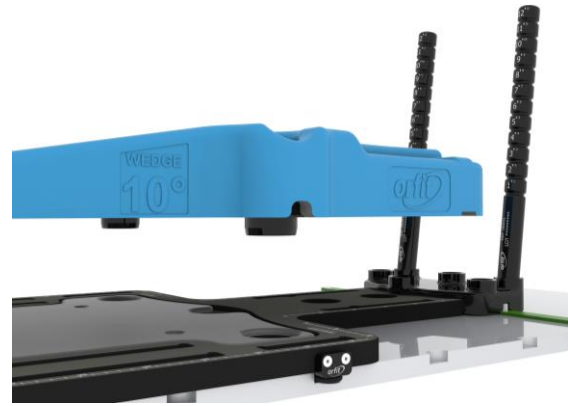

A 15° angle can be obtained by combining the 5° (38103) and 10° (38102) wedge cushions. The 5° wedge cushion should be indexed on the AIO 3.0 base plate and the 10° wedge cushion is indexed on top of the 5° wedge.

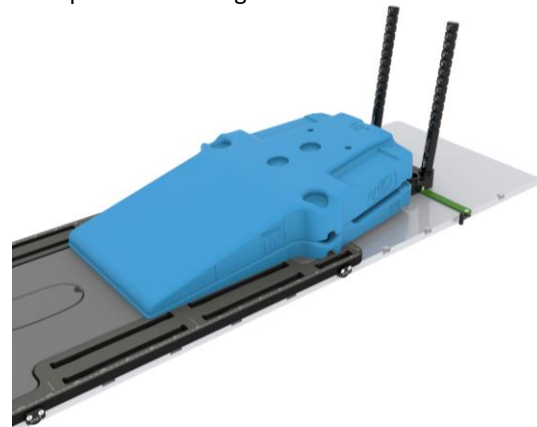

The arm rest low (38106) and high (38100) can be indexed on the 0 degree cushion or the 5° and 10° wedge cushions in exactly the same way by using the indexing knobs already provided in the cushion itself. The indexing knobs will fit into the positioning holes provided in the 0 degree cushion and the base plates or into the positioning holes provided on top of the 5° and 10° wedge cushion.

The 5° and 10° wedge cushions and arm rest high and low can also be indexed directly onto the simulation and treatment couch without using a base plate. The 5° and 10° wedge cushions are indexed by means of 2-pin or 3-pin indexing bars and standalone grip pole block 38004.

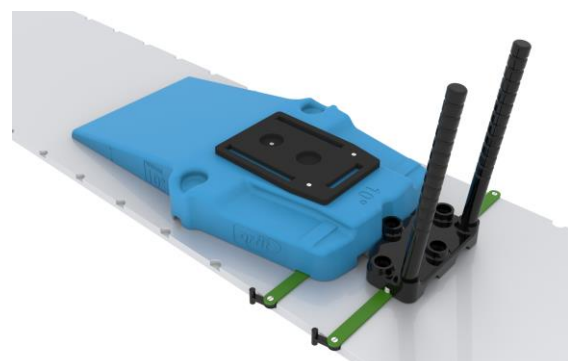

When indexing the 10° wedge cushion directly onto the simulation and treatment couch, the indexing knobs are inserted with the smallest part into the holes provided at the bottom of the cushion. In this way the knobs are not protruding and stored, allowing the cushions to lay flat on the couch. When indexing the 5° wedge cushion directly onto the simulation and treatment couch, the indexing knobs should be removed. The indexing knobs cannot be stored in the 5° wedge cushion itself. The standalone grip pole block support frame 38004 fits into the cut-out provided on the bottom side of the 5° and 10° wedge cushions and fits over a 2-pin or 3-pin indexing bar.

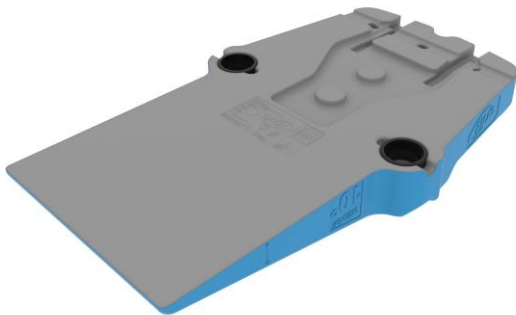

The arm rest high and low can be indexed directly onto the simulation and treatment couch using a 2-pin or 3-pin indexing bar. For more information about the positioning of the head of the patient, see 'standalone grip pole block support frame 38004' section below.

Arm rest extension (38130) is an additional cushion that can be placed on top of the arm rest high (38100). The arm rest extension is designed to offer more comfort to patients with limited shoulder mobility in the overhead arm position. Always make sure the Arm rest extension (38130) is firmly positioned on top of the arm rest.

Always verify that the cushions are correctly positioned on the base plates or the simulation and treatment couch.

The blue breast- and lung immobilisation cushions can be combined with the grey knee and leg immobilisation cushions to create a comfortable and reproducible position of the patient. More information on these cushions can be found in the respective 'instructions for use' and on www.orfit.com.

The cushions used on the treatment machines are often used more frequently than those on the simulators and during the imaging stages. Therefore we recommend rotating the cushion sets between the different machines on a regular

base to avoid differences in wear and tear of the cushions.

Do not expose the cushions to a hot air blower and make sure that no sharp objects can come into contact with the cushions.

Do not use tape on the cushions.

Note: these cushions cannot be used on the 1st or 2nd generation AIO base plates.

Secondary base plates 38003 & 38007

The secondary base plates allow the use of 4-points lung and thorax masks, 5-points asymmetric breast masks and 6-points thorax masks in combination with the 3.0 blue AIO breast- & lung immobilisation cushions.

These secondary base plates have 3 positioning knobs on the bottom that fit into the positioning holes provided in the 5° and 10° wedge cushions and they can be indexed directly to all AIO 3.0 base plates when the 5° or 10° wedges are not in place. The secondary base plates cannot be indexed directly onto the simulation and treatment couch. Always verify that the secondary base plate is correctly positioned and indexed.

Hand positioning accessories 38200, 38201, 38223 & 38238

The grip pole collar (38200), grip pole long (38201), grip pole short (38223) and grip pole extra long allow comfortable and reproducible positioning of the hands of the patients during thoracic treatments with the AIO 3.0 Solution Breast- & Lungboard.

To index the grip pole collar on the AIO 3.0 base plates, slide it onto the cranial end of the base plates. 1 or 2 grip poles can be inserted in the positioning holes provided in the grip pole collar. The grip pole collar can be indexed to the couch with a 2-pin or 3-pin indexing bar (see image below).

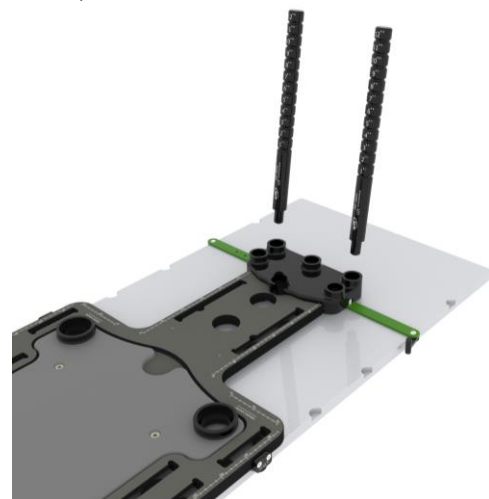

When the AIO 3.0 Solution Breast- & Lungboard is used without one of the AIO 3.0 base plates, the grip pole collar can be slid onto the cranial end of the standalone grip pole block support frame 38004. For more information, see 'standalone grip pole block support frame 38004' section below.

Always verify that the grip pole collar and grip pole long or short are correctly positioned and indexed on the base plate or the couch. Do not apply excessive force on the grip poles. Make sure the patient doesn't use the grip poles for repositioning or for getting off the board.

Standalone grip pole block support frame 38004 & Connection pin 38236

The standalone grip pole block support frame is used to index the hands and head of breast & lung patients when treated without the use of one of the AIO 3.0 base plates. The standalone grip pole block support frame is used in combination with the grip pole collar and Raycast® High Precision Head Supports to create a comfortable and reproducible position of the patient.

The standalone grip pole block support frame is indexed to the simulation and treatment couch by means of a 2-pin or 3-pin indexing bar. The grip pole collar is slid onto the cranial side of the standalone grip pole block support frame and can be locked by inserting connection pin 38236 or 1 or 2 grip poles into the 3 most caudal positioning holes provided in the grip pole collar (see image below). The grip pole collar can also be locked to any AIO 3.0 base plate by using this connection pin 38236.



Always verify that the standalone grip pole block support frame is correctly positioned and indexed on the simulation and treatment couch.

When using the connection pin 38236 to connect the standalone grip pole block support frame and the grip pole collar, make sure to push the pin firmly in one of the 3 most caudal holes. Do not turn the assembly upside-down as the connection pin may fall out. Do not store it as an assembly but instead store all items separately.

A patient set-up form is available on the Orfit website.

E. STORAGE

Always store the products in a safe place to prevent them from getting damaged or falling onto other objects. Do not put heavy objects on the cushions and prevent hard objects from falling onto them to prevent permanent deformations. Avoid pressure points on the cushions during storage as these can cause imprints in the cushions. The imprints will disappear overtime when the pressure is released.

Store the hand positioning accessories in such a way that they cannot fall or bump against anything. Never place the grip poles under load or pressure.

Store the system between +10°C (50°F) and 40°C (104°F).

F. PROPERTIES

38003: AIO 3.0 – Secondary base plate – High density

Physical properties:

Dimensions: L 285 mm x W 200 mm x H 22 mm
L 11.22" x W 7.87" x H 0.87"

Weight: 330 g



This product is made entirely of electrically non-conductive, non-metallic and non-magnetic materials and is MR safe.

Mechanical properties:

The AIO 3.0 Secondary base plate – High density is made of materials which keeps its dimensions overtime and under conditions of frequent use.

Dosimetric properties:

This product is made of a high density material and is not intended to treat through.

38007: AIO 3.0 – Secondary base plate – Low density

Physical properties:

Dimensions: L 285 mm x W 200 mm x H 22 mm
L 11.22" x W 7.87" x H 0.87"

Weight: 80 g



This product is made entirely of electrically non-conductive, non-metallic and non-magnetic materials and is MR safe.

Mechanical properties:

The AIO 3.0 Secondary base plate – Low density is made of materials which keeps its dimensions overtime and under conditions of frequent use.

Dosimetric properties:

Attenuation factor ($\pm 0.15\%$)	
6MV	1.3%
10 MV	0.85%
H ₂ O equivalence	3.7mm

Note: Use these numbers as a guidance only. Perform the measurements again in your department to verify these results.

38004: AIO 3.0 – Standalone grip pole block support frame

Physical properties:

Dimensions: 455 mm x 228.6 mm x 20.5 mm
17.91 " x 9 " x 0.81 "

Weight: 770 g



This product is made entirely of electrically non-conductive, non-metallic and non-magnetic materials and is MR safe.

Mechanical properties:

The AIO 3.0 standalone grip pole block support frame is made of materials which keeps its dimensions overtime and under conditions of frequent use.

Dosimetric properties:

This product is made of a high density material and is not intended to treat through. The product is not located in the treatment area.

38100: AIO 3.0 – Arm rest high

Physical properties:

Dimensions: L 400 mm x W 528 mm x H 236 mm
L 15.75" x W 20.79" x H 9.29"

Weight: 840 g

Density foam: 50 kg/m³



This product is made entirely of electrically non-conductive, non-metallic and non-magnetic materials and is MR safe.

Mechanical properties:

The AIO 3.0 cushions are made of a low density foam that is covered with a coating. This combination results in a stable cushion that keeps its dimensions overtime and under conditions of frequent use.

Dosimetric properties:

The attenuation and skin build-up at 6 MV and 15 MV per cm of material:

Attenuation ($\pm 0.15\%$)		Skin Build-up (± 0.1 mm)	
6 MV	15 MV	6 MV	15 MV
0.25%	0.15%	0.6 mm	0.6 mm

Note: Use these numbers as a guidance only. Perform the measurements again in your department to verify these results.

38106: AIO 3.0 – Arm rest low

Physical properties:

Dimensions: L 417 mm x W 524 mm x H 152 mm
L 16.42" x W 20.63" x H 5.98"

Weight: 770 g

Density foam: 50 kg/m³



This product is made entirely of electrically non-conductive, non-metallic and non-magnetic materials and is MR safe.

Mechanical properties:

The AIO 3.0 cushions are made of a low density foam that is covered with a coating. This combination results in a stable cushion that keeps its dimensions overtime and under conditions of frequent use.

Dosimetric properties:

The attenuation and skin build-up at 6 MV and 15 MV per cm of material:

Attenuation ($\pm 0.15\%$)		Skin Build-up (± 0.1 mm)	
6 MV	15 MV	6 MV	15 MV
0.25%	0.15%	0.6 mm	0.6 mm

Note: Use these numbers as a guidance only. Perform the measurements again in your department to verify these results.

38130: AIO 3.0 – Arm rest extension

Physical properties:

Dimensions: L 405 mm x W 577 mm x H 184 mm
L 15.94" x W 22.70" x H 7.24"

Weight: 520 g / 1,15 lbs

Density foam: 50 kg/m³



This product is made entirely of electrically non-conductive, non-metallic and non-magnetic materials and is MR safe.

Mechanical properties:

The AIO 3.0 cushions are made of a low density foam that is covered with a coating. This combination results in a stable cushion that keeps its dimensions overtime and under conditions of frequent use.

Caution:

Do not place any load on the cushion when it is not positioned on the arm rest high (Art. No. 38130).

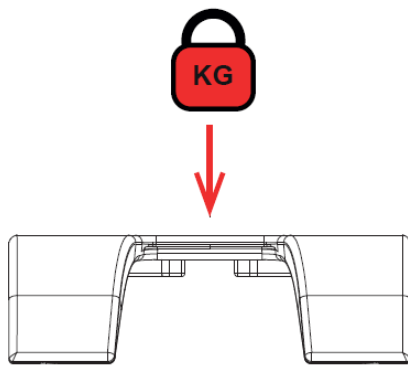

Do not press sides together

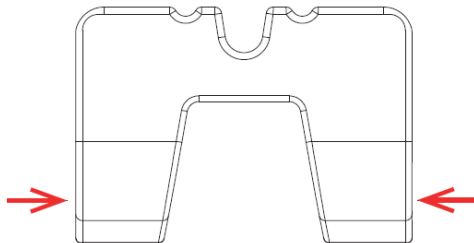

Dosimetric properties:

The attenuation and skin build-up at 6 MV and 15 MV per cm of material:

Attenuation (± 0.15%)		Skin Build-up (± 0.1 mm)	
6 MV	15 MV	6 MV	15 MV
0.25%	0.15%	0.6 mm	0.6 mm

Note: Use these numbers as a guidance only. Perform the measurements again in your department to verify these results.

38101: AIO 3.0 – 0 degree cushion - Adult

Physical properties:

Dimensions: L 910 mm x W 465 mm x H 6 mm
L 35.83" x W 18.31" x H 0.24"

Weight: 175 g

Density foam: 50 kg/m³



This product is made entirely of electrically non-conductive, non-metallic and non-magnetic materials and is MR safe.

Mechanical properties:

The AIO 3.0 cushions are made of a low density foam that is covered with a coating. This combination results in a stable cushion that keeps its dimensions overtime and under conditions of frequent use.

Dosimetric properties:

The attenuation and skin build-up at 6 MV and 15 MV per cm of material:

Attenuation (± 0.15%)		Skin Build-up (± 0.1 mm)	
6 MV	15 MV	6 MV	15 MV
0.25%	0.15%	0.6 mm	0.6 mm

Note: Use these numbers as a guidance only. Perform the measurements again in your department to verify these results.

38102: AIO 3.0 – Wedge 10°

Physical properties:

Dimensions: L 775 mm x W 461 mm x H 86 mm
L 30.51" x 18.15" x H 3.39"

Weight: 1050 g

Density foam: 50 kg/m³



This product is made entirely of electrically non-conductive, non-metallic and non-magnetic materials and is MR safe.

Mechanical properties:

The AIO 3.0 cushions are made of a low density foam that is covered with a coating. This combination results in a stable cushion that keeps its dimensions overtime and under conditions of frequent use.

Dosimetric properties:

The attenuation and skin build-up at 6 MV and 15 MV per cm of material:

Attenuation (± 0.15%)		Skin Build-up (± 0.1 mm)	
6 MV	15 MV	6 MV	15 MV
0.25%	0.15%	0.6 mm	0.6 mm

Note: Use these numbers as a guidance only. Perform the measurements again in your department to verify these results.

38103: AIO 3.0 – Wedge 5°

Physical properties:

Dimensions: L 775 mm x W 461 mm x H 76 mm
L 30.51" x 18.15" x H 2.99"

Weight: 830 g

Density foam: 50 kg/m³



This product is made entirely of electrically non-conductive, non-metallic and non-magnetic materials and is MR safe.

Mechanical properties:

The AIO 3.0 cushions are made of a low density foam that is covered with a coating. This combination results in a stable cushion that keeps its dimensions overtime and under conditions of frequent use.

Dosimetric properties:

The attenuation and skin build-up at 6 MV and 15 MV per cm of material:

Attenuation (± 0.15%)		Skin Build-up (± 0.1 mm)	
6 MV	15 MV	6 MV	15 MV
0.25%	0.15%	0.6 mm	0.6 mm

Note: Use these numbers as a guidance only. Perform the measurements again in your department to verify these results.

38200: AIO 3.0 – Grip pole collar

Physical properties:

Dimensions: L 145 mm x W 240 mm x H 46 mm
L 5.71" x W 9.45" x H 1.81"

Weight: 280 g



This product is made entirely of electrically non-conductive, non-metallic and non-magnetic materials and is MR safe.

Mechanical properties:

The AIO 3.0 grip pole collar is made of a composite material which keeps its dimensions overtime and under conditions of frequent use.

Dosimetric properties:

This product is made of a high density material and is not intended to treat through. The product is not located in the treatment area.

38201: AIO 3.0 – Grip pole long

Physical properties:

Dimensions: L 30 mm x W 30 mm x H 431 mm
L 1.18" x W 1.18" x H 16.97"

Weight: 275 g



This product is made entirely of electrically non-conductive, non-metallic and non-magnetic materials and is MR safe.

Mechanical properties:

The AIO 3.0 grip pole long is made of a composite material which keeps its dimensions over time and under conditions of frequent use.

Dosimetric properties:

This product is made of a high density material and is not intended to treat through. The product is not located in the treatment area.

38223: AIO 3.0 – Grip pole short

Physical properties:

Dimensions: L 30 mm x W 30 mm x H 364 mm
L 1.18" x W 1.18" x H 14.33"

Weight: 250 g



This product is made entirely of electrically non-conductive, non-metallic and non-magnetic materials and is MR safe.

Mechanical properties:

The AIO 3.0 grip pole short is made of a composite material which keeps its dimensions over time and under conditions of frequent use.

Dosimetric properties:

This product is made of a high density material and is not intended to treat through. The product is not located in the treatment area.

38238: AIO 3.0 – Grip pole extra long

Physical properties:

Dimensions: L 30 mm x W 30 mm x H 506 mm
L 1.18" x W 1.18" x H 16.97"

Weight: 300 g



This product is made entirely of electrically non-conductive, non-metallic and non-magnetic materials and is MR safe.

Mechanical properties:

The AIO 3.0 grip pole extra long is made of a composite material which keeps its dimensions over time and under conditions of frequent use.

Dosimetric properties:

This product is made of a high density material and is not intended to treat through. The product is not located in the treatment area.

38202: AIO 3.0 – Indexing knob for cushions

Physical properties:

Dimensions: L 66 mm x W 66 mm x H 32 mm
L 2.60" x W 2.60" x H 1.26"

Weight: 45 g



This product is made entirely of electrically non-conductive, non-metallic and non-magnetic materials and is MR safe.

Mechanical properties:

The AIO 3.0 indexing knob for cushions is made of a composite material which keeps its dimensions overtime and under conditions of frequent use.

Dosimetric properties:

This product is made of a high density material and is not intended to treat through. The product is not located in the treatment area.

38211/6: AIO 3.0 – Set of 6 pins for 0° cushion

Physical properties:

Dimensions: 18.7 mm x 14.8 mm (diameter)
0.74" x 0.58" (diameter)

Weight: 5.8



This product is made entirely of electrically non-conductive, non-metallic and non-magnetic materials and is MR safe.

Mechanical properties:

The AIO 3.0 pins for 0° cushion are made of a composite material which keeps its dimensions overtime and under conditions of frequent use.

Dosimetric properties:

This product is made of a low material and can be treated through.

38117: AIO 3.0 – 0 degree cushion for paediatric base plates – without leg separator

Physical properties:

Dimensions: L 910 mm x W 465 mm x H 6 mm
L 35.83" x W 18.31" x H 0.24"

Weight: 160 g

Density foam: 50 kg/m³



This product is made entirely of electrically non-conductive, non-metallic and non-magnetic materials and is MR safe.

Mechanical properties:

The AIO 3.0 cushions are made of a low density foam that is covered with a coating. This combination results in a stable cushion that keeps its dimensions overtime and under conditions of frequent use.

Dosimetric properties:

The attenuation and skin build-up at 6 MV and 15 MV per cm of material:

Attenuation (± 0.15%)		Skin Build-up (± 0.1 mm)	
6 MV	15 MV	6 MV	15 MV
0.25%	0.15%	0.6 mm	0.6 mm

Note: Use these numbers as a guidance only. Perform the measurements again in your department to verify these results.

38118: AIO 3.0 – 0 degree cushion for paediatric base plates – with leg separator

Physical properties:

Dimensions: L 910 mm x W 465 mm x H 6 mm
L 35.83" x W 18.31" x H 0.24"

Weight: 160 g

Density foam: 50 kg/m³



This product is made entirely of electrically non-conductive, non-metallic and non-magnetic materials and is MR safe.

Mechanical properties:

The AIO 3.0 cushions are made of a low density foam that is covered with a coating. This combination results in a stable cushion that keeps its dimensions overtime and under conditions of frequent use.

Dosimetric properties:

The attenuation and skin build-up at 6 MV and 15 MV per cm of material:

Attenuation (± 0.15%)		Skin Build-up (± 0.1 mm)	
6 MV	15 MV	6 MV	15 MV
0.25%	0.15%	0.6 mm	0.6 mm

Note: Use these numbers as a guidance only. Perform the measurements again in your department to verify these results.

38236: AIO 3.0 – Grip pole collar connection pin

Physical properties:

Dimensions: L 30 mm x W 30 mm x H 61 mm
L 1.18" x W 1.18" x H 2.40"

Weight: 30 g



This product is made entirely of electrically non-conductive, non-metallic and non-magnetic materials and is MR safe.

Mechanical properties:

The AIO 3.0 grip pole collar connection pin is made of a composite material which keeps its dimensions overtime and under conditions of frequent use.

Dosimetric properties:

This product is made of a high density material and is not intended to treat through. The product is not located in the treatment area.

G. MAINTENANCE AND WASTE MANAGEMENT

These products can be cleaned and disinfected by means of an isopropanol based disinfectant, applied with a soft cloth. If unsure about the cleaning fluid, do not use. **Never use aerosol sprays, corrosive cleaning agents, solvents or abrasive detergents. Do not soak the products.** Further cleaning instructions can be found in the [Orfit Cleaning Guidelines](#).

Note:

It is prohibited to make alterations to this text without prior approval from Orfit Industries. THE AIO SOLUTION® is a registered trademark of Orfit Industries.



ORFIT INDUSTRIES
Vosveld 9A | B-2110 Wijnegem | Belgium
T (+32) (0)3 326 20 26
welcome@orfit.com

www.orfit.com



Ref. No. 50194
VERSION 19
LAST UPDATE: 03/08/2023
REVISION DATE: 03/08/2025

The AIO 3.0 cushions are made of a closed-cell foam and will not absorb any cleaning agent. Periodic checks of these products should be done to insure the parts are not worn and require repair or replacement. **Do not attempt to make repairs yourself.** Contact your distributor if there are any questions or concerns.

These products can be disposed of with household waste.

H. ADDITIONAL INFORMATION

The pictures below give an idea of the dimensions of the complete AIO 3.0 Breast & Lungboard set and the minimum bore size (CT scanner etc.) needed for a clear pass. If a certain

cushion setup cannot enter the bore, it is recommended to remove the arm rest and grip poles, slide the table through the bore and replace the arm rest and grip poles from the backside of the scanner.

The first view represents a setup of base plate, 0 degree cushion, 10° wedge and arm rest high together with two long grip poles and has a diameter of 628mm:

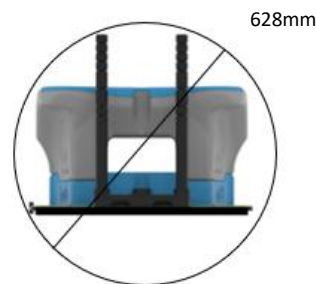

The second view is of a lower setup without base plate (Standalone grip pole block support frame, 10° wedge and arm rest high together with two grip poles) and has a diameter of 572,2mm:

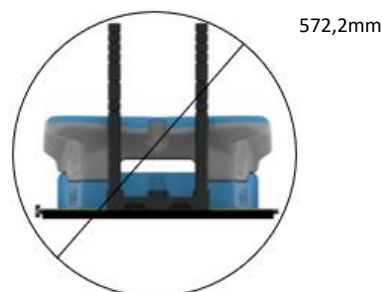

For additional information such as distributor contact information, product brochures, Safety Data Sheets and regulatory information, please visit our website www.orfit.com.